

# N

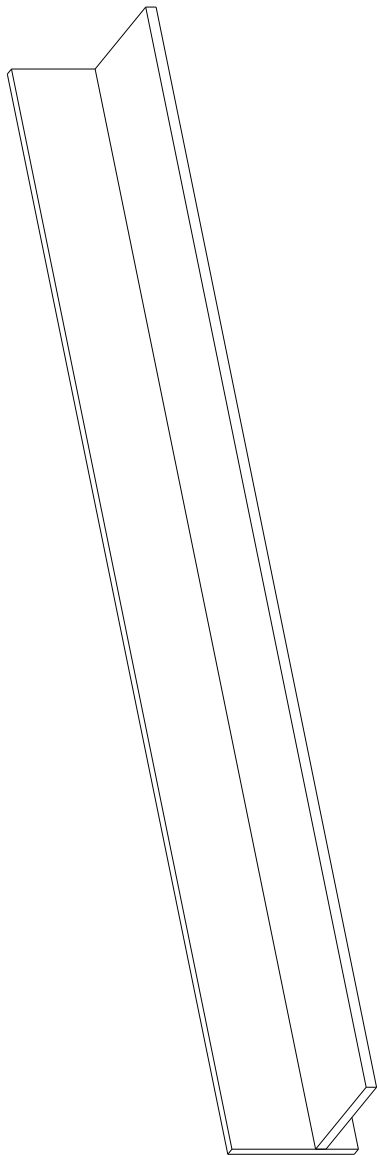

30 min

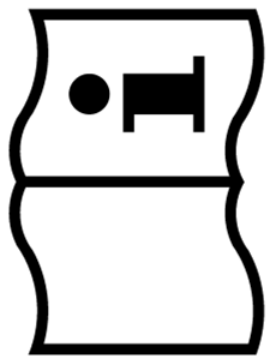

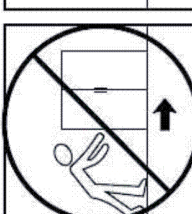
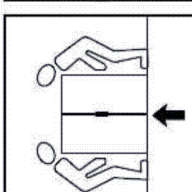
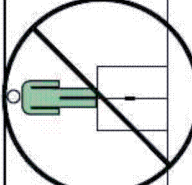
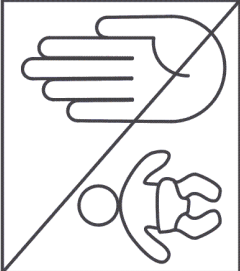
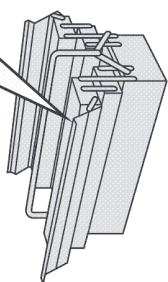
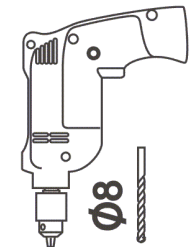
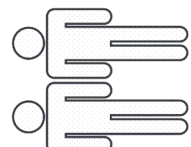
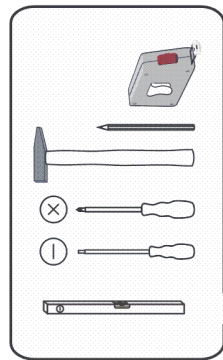
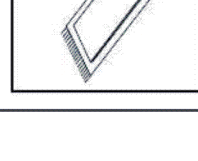
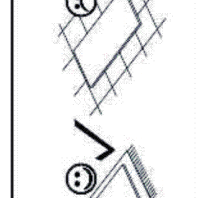
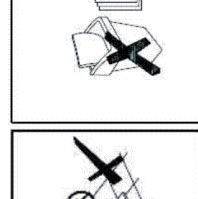
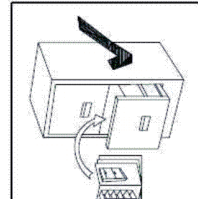
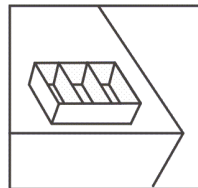
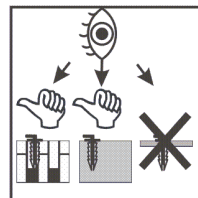
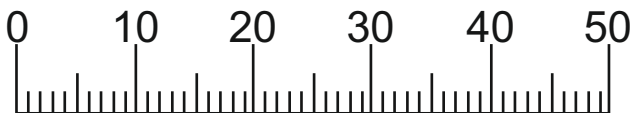
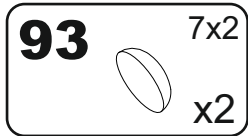
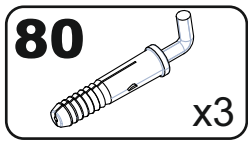
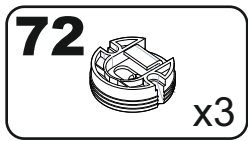
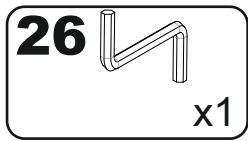
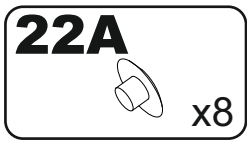
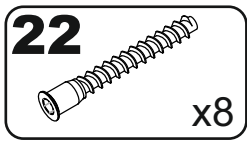
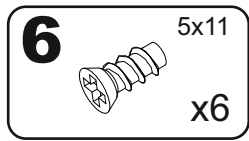
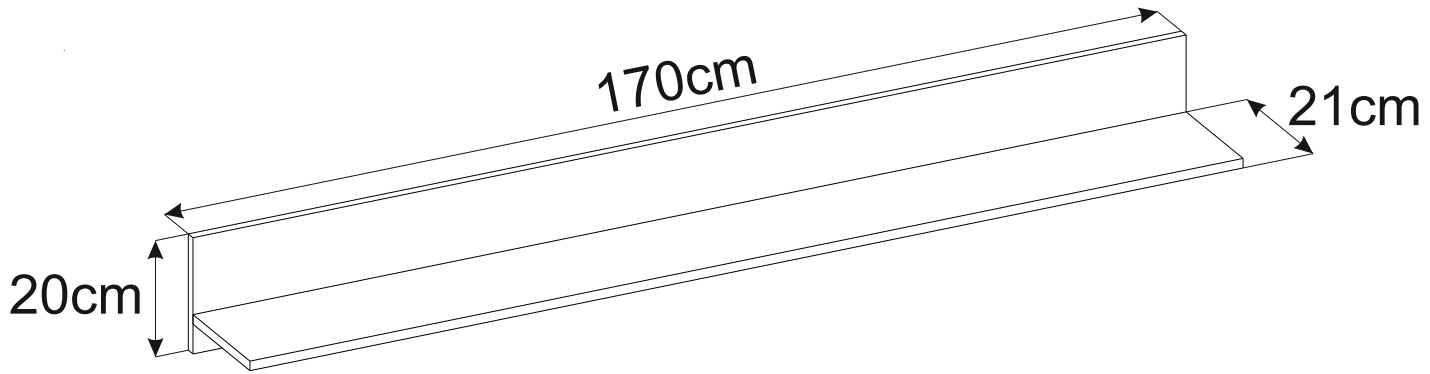
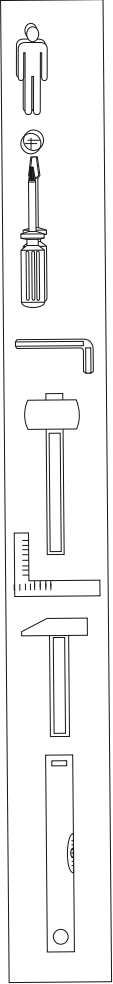

N

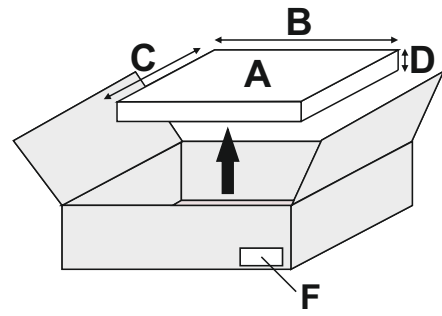
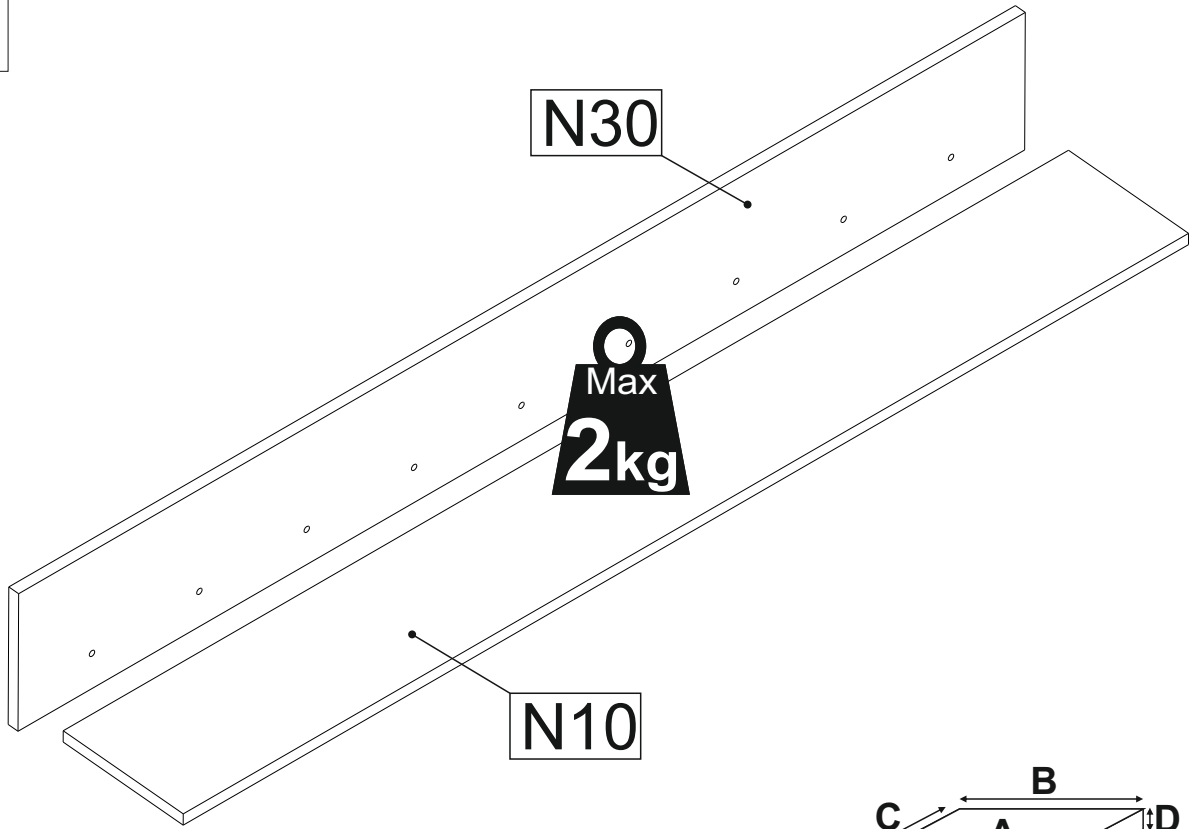
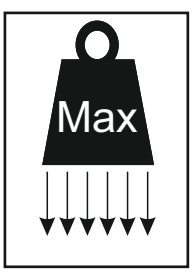

A	B (mm)	C (mm)	D (mm)	E	F
N10	1700	195	16	1	1 1
N30	1700	195	16	1	1 1

# I

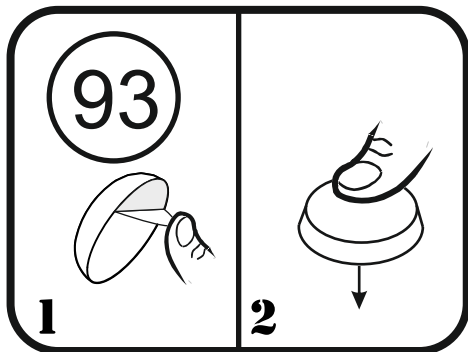
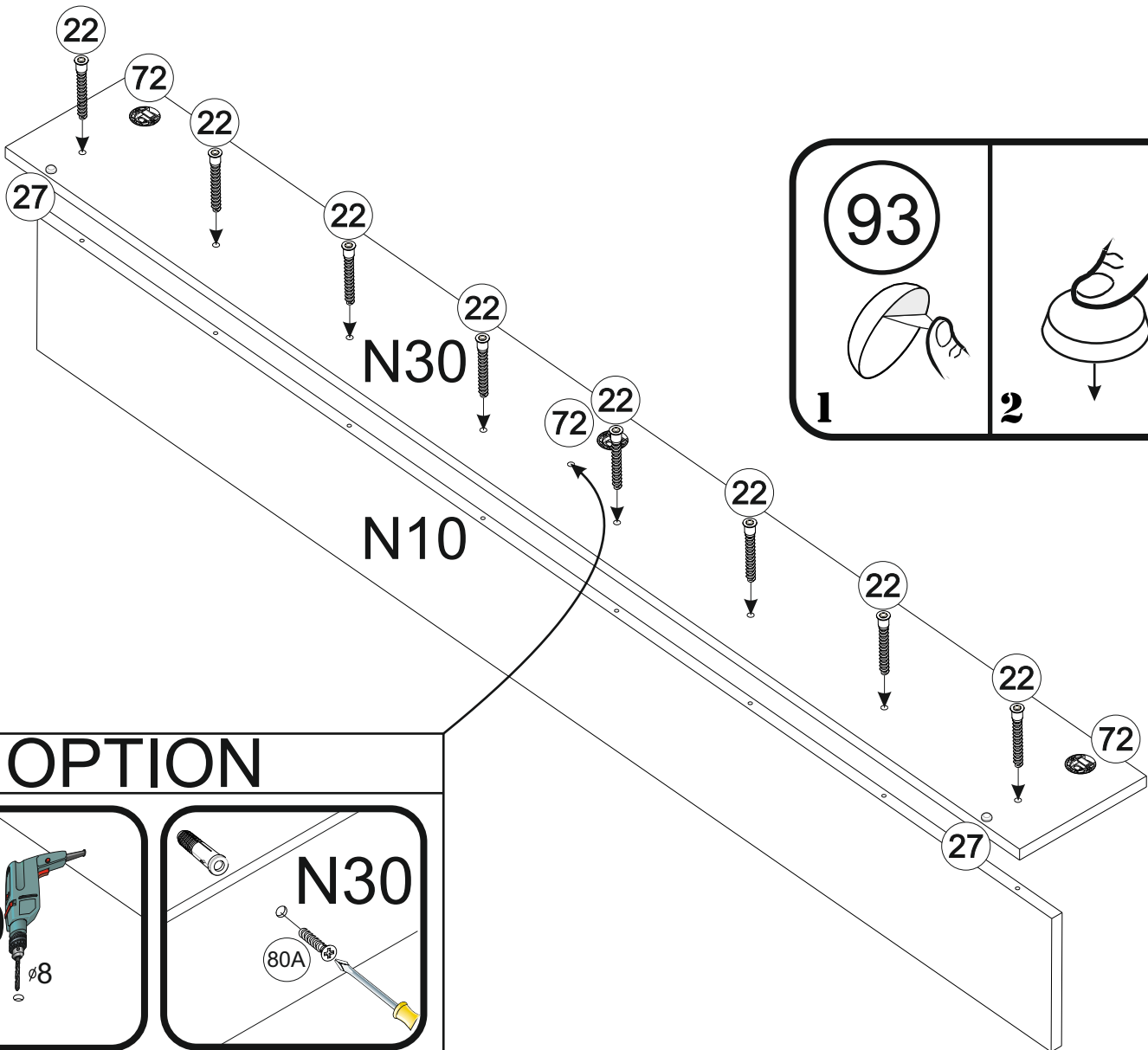
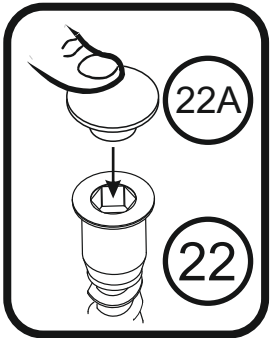
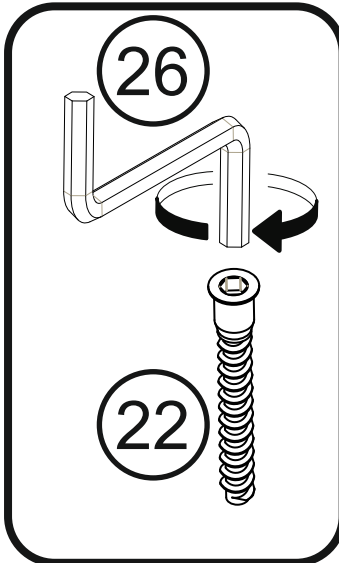
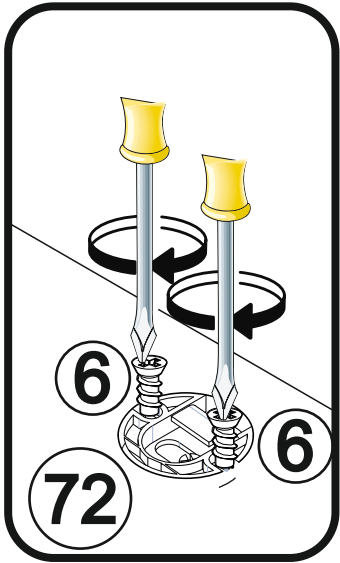
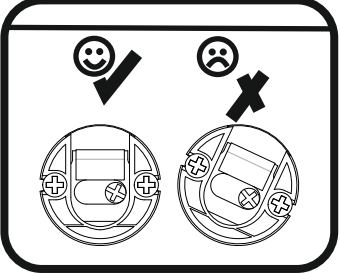
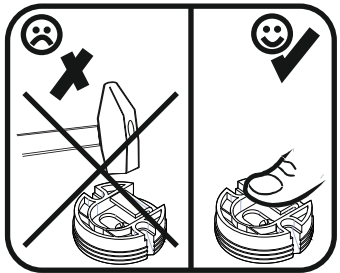
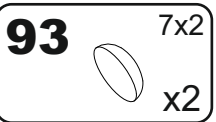
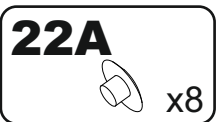
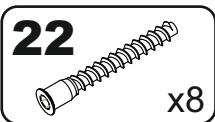
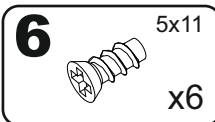

## OPTION

